

Die äußeren Seiten des Anschlagprofils müssen fest am Korpus montiert sein und ganzflächig aufliegen.

The complete outer sides of the stop profile must be firmly fixed to the base.

Darstellung  
 Image **80%**

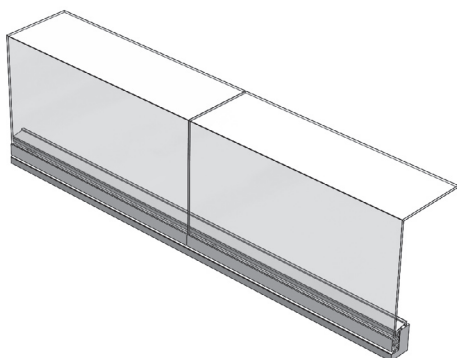

Kippbeschlag für senkrechtes Frontglas  
 max. Frontglasgröße L = 1250 mm H = 700 mm  
 max. Deckglastiefe T = 500 mm







Tilting armature for vertical counter  
 max. front glass size L = 1250 mm H = 700 mm  
 max. upper glass size T = 500 mm

Wir empfehlen ESG-Glas in allen Thekenaufbauten zu verwenden.

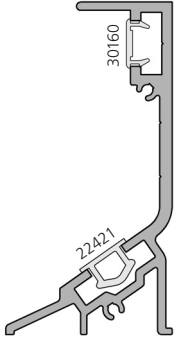
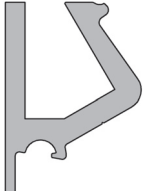
We recommend always toughened safety glass for all our systems.

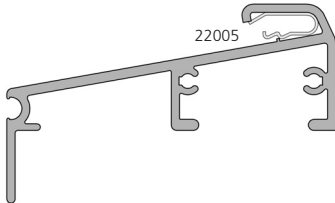
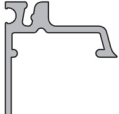
Kippbeschlag<sup>®</sup>  
 Tilting armature<sup>®</sup>

# 224

	Anschlagprofil, Aluminium Stop profile	6000 mm	<b>12230</b>
	Glashalteprofil, Aluminium Glass holding profile	6000 mm Bohrabstand Bore distance 150 mm	<b>12223</b>
	Schraube M6 x 10 DIN 913 Screw M6 x 10 DIN 913	VPE 25 PU 25	<b>SC003</b>
	Klemmprofil, Aluminium Clamping profile	6000 mm	<b>12224</b>
	Preisschienenprofil, Aluminium Price-tag rail	6000 mm	<b>12220</b>
	Preisschienenprofil, Aluminium Price-tag rail	6000 mm	<b>12225</b>
	Einfassprofil, Weich-PVC transparent Bordering profile, Soft-PVC transparent	3000 mm 6 mm Glas/glass 8 mm Glas/glass	<b>22411</b> <b>22413</b>
	Rundschnur, Weich-PVC Cord profile, Soft-PVC	Ø 4 mm	<b>00535</b>
	Abdeckprofil, Weich-PVC Covering profile, Soft-PVC	3000 mm	<b>22421</b>
	Abdeckprofil, PVC Covering profile, PVC	6000 mm	<b>30160</b>

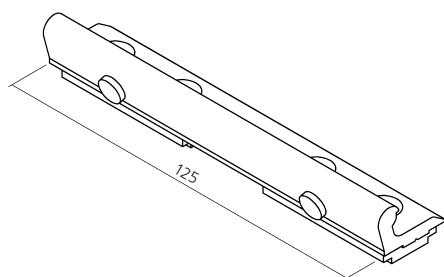

Kipplager mit Dämpfung  
3 Stück / Glas  
Tilting bearing with damping  
3 pieces / glass

**22410**

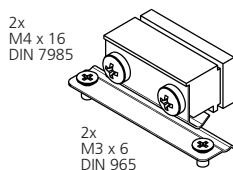

Arretierung  
Locking mechanism

**22400**

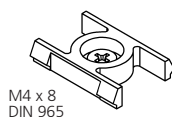

Verbindungsclip, Polyamid  
Connecting clip, Polyamide

**22405**

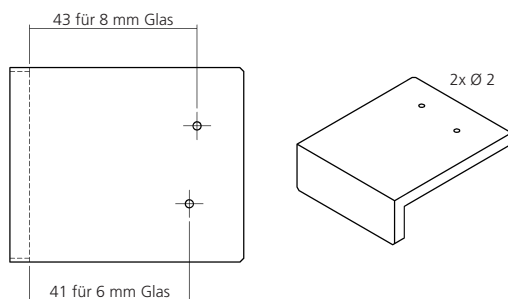

Bohrschablone - 12220  
für Verbindungsclip 22405  
Drilling jig - 12220  
for connecting clip 22405

**23481**

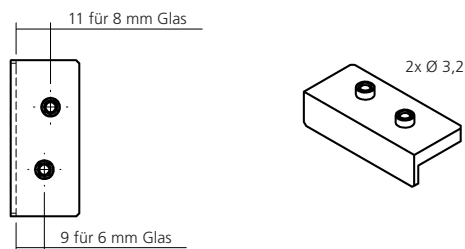

Bohrschablone - 12230  
für Verbindungsclip 22405  
Drilling jig - 12230  
for connecting clip 22405

**23482**

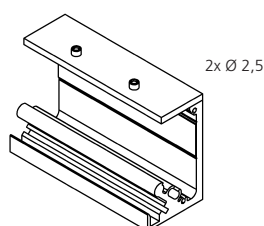

Bohrschablone - Glashalteprofil  
für Arretierung 22403  
Drilling jig - glass holding profile  
for locking mechanism 22403

**23483**

Kippbeschlag<sup>®</sup>  
Tilting armature<sup>®</sup>

# 224

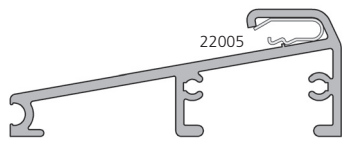

Preisschienenprofil, Aluminium  
Price-tag rail

6000 mm

**12219**

Klemmprofil, PVC  
Clamping profile

3000 mm

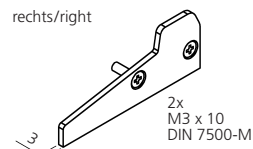
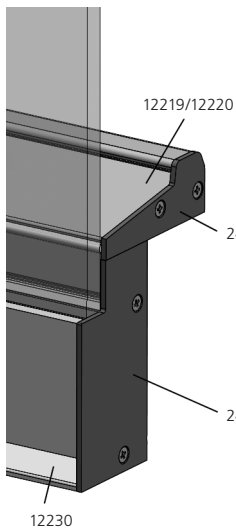
**22005**

Endkappe, Aluminium  
für Profil 12219 / 20  
End cap  
for profile 12219 / 20

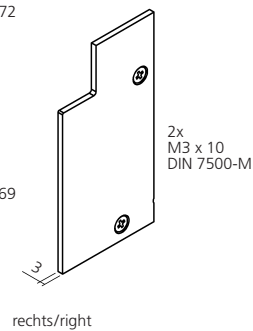
rechts/right  
links/left**24071****24072**

Endkappe, Aluminium  
für Profil 12230  
End cap  
for profile 12230

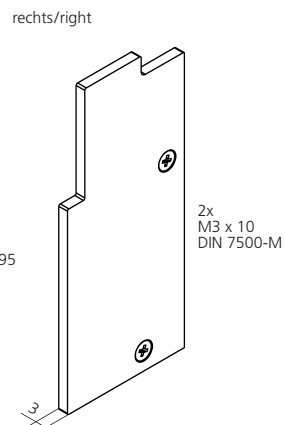
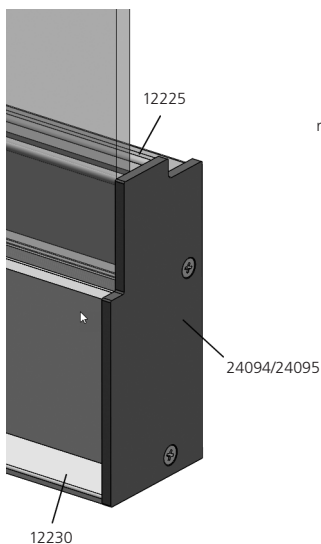
rechts/right  
links/left**24068****24069**

Endkappe, Aluminium  
für Profil 12230 / 12225  
End cap  
for profile 12230 / 12225

rechts/right  
links/left**24094****24095**