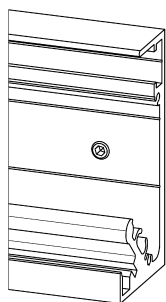
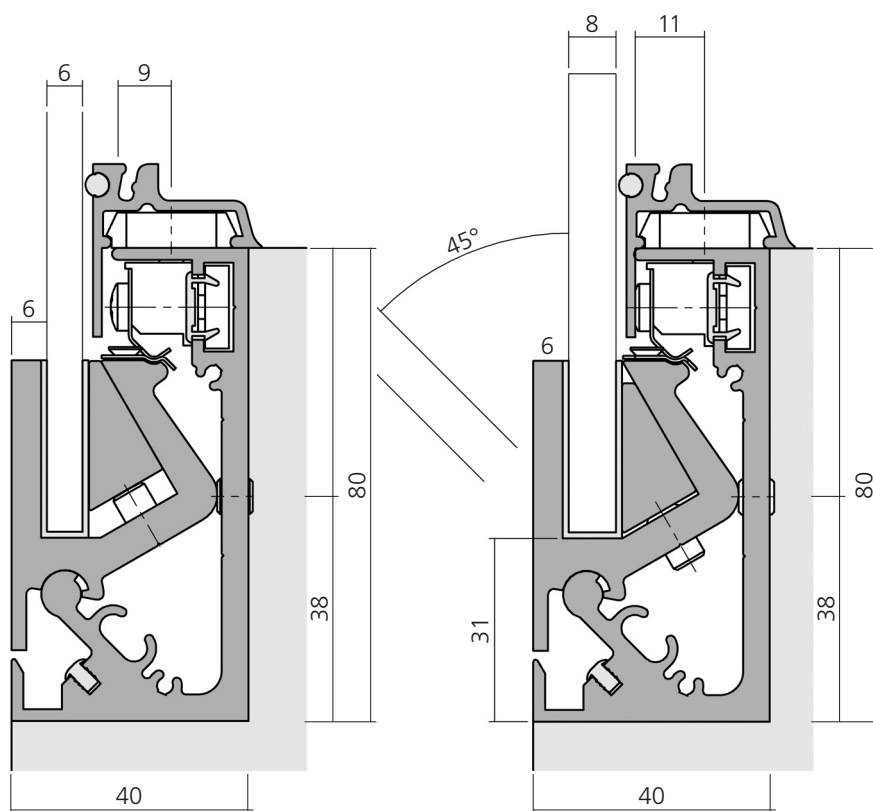
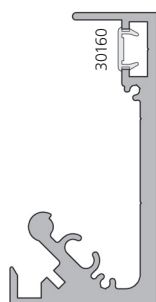

 max. Glasgröße
 max. glass size

 M6 x 6
 DIN 913

Gewinde M6 für Einstellschraube,
 bauseits 2 Einstellschrauben je Glas
 Adjustable screw, drill by customer
 2 screws each glass

Die äußeren Seiten des Anschlag-
 profils müssen fest am Korpus mon-
 tiert sein und ganzflächig aufliegen.

The complete outer sides of the
 stop profile must be firmly fixed
 to the base.

 Darstellung
 Image **80%**

 Anschlagprofil, Aluminium
 Stop profile

6000 mm

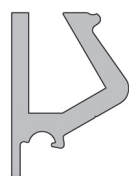
12222
 Schraube M6 x 6 DIN 913
 Screw M6 x 6 DIN 913

 VPE 25
 PU 25
SC005
 Glshalteprofil, Aluminium
 Glass holding profile

6000 mm

12223
 Bohrabstand
 Bore distance
 150 mm

 Schraube M6 x 10 DIN 913
 Screw M6 x 10 DIN 913

 VPE 25
 PU 25
SC003
 Klemmprofil, Aluminium
 Clamping profile

6000 mm

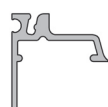
12224
 Preisschienenprofil, Aluminium
 Price-tag rail

6000 mm

12225

Kippbeschlag[®]
 Tilting armature[®]

225

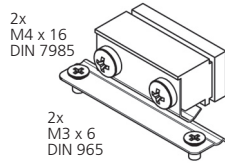
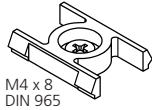
 Arretierung
 Locking mechanism
22403
 Verbindungsclip, Polyamid
 Connecting clip, Polyamide
22405
 Einfassprofil, Weich-PVC
 transparent
 Bordering profile, Soft-PVC
 transparent

 3000 mm
 6 mm Glas/glass
 8 mm Glas/glass
22411**22413**
 Farbe: transp. und schwarz
 Colour: transp. and black

 Abdeckprofil, Weich-PVC
 Covering profile, Soft-PVC
22418
 Abdeckprofil, PVC
 Covering profile, PVC

6000 mm

30160
 Rundschnur, Weich-PVC
 Cord profile, Soft-PVC

4 mm

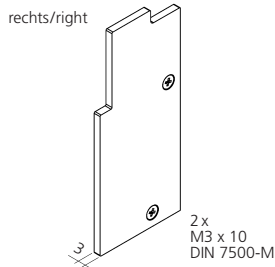
00535
 Endkappe, Aluminium
 End cap

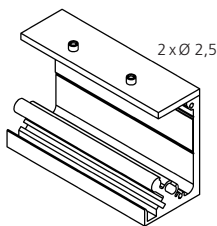
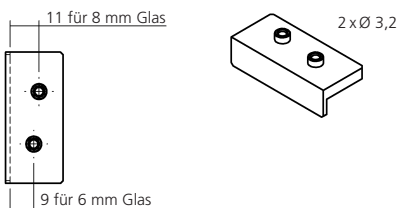
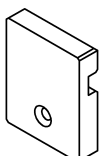
 rechts/right
 links/left
24094**24095**
 Bohrschablone – Glashalteprofil
 für Arretierung 22403
 Drilling jig – glass holding profile
 for locking mechanism 22403
23483
 Bohrschablone
 für Verbindungsclip 22405
 Drilling jig
 for connecting 22405
23482
 Bohrschablone, Stahl
 für Einstellschraube M6 x 6 DIN 913
 Drilling jig, steel
 for adjusting screw M6 x 6 DIN 913
23490