

Zwischenträger
 Intermediate bracket

270

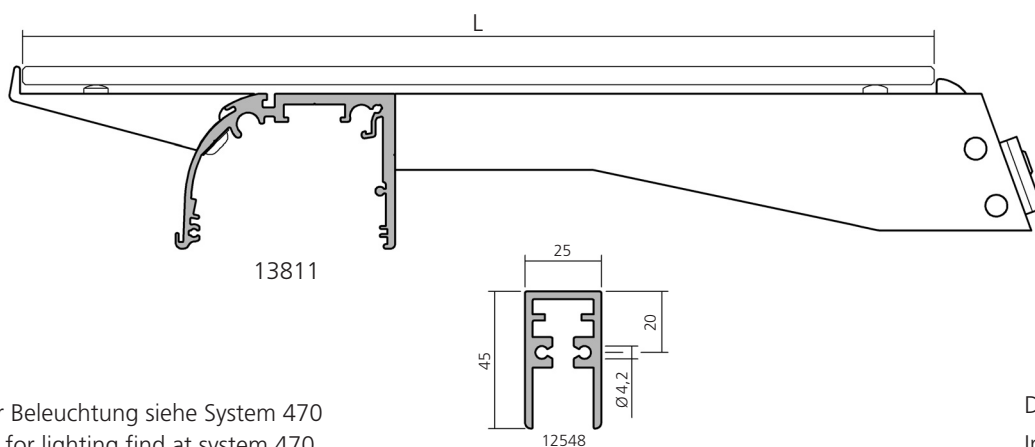

 Zubehör für Beleuchtung siehe System 470
 Accessories for lighting find at system 470

 Darstellung
 Image **40%**

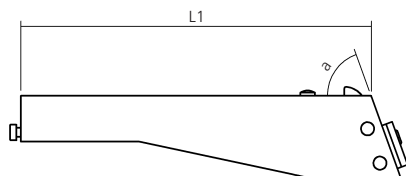
 Zwischenträger, Aluminium
 Intermediate bracket

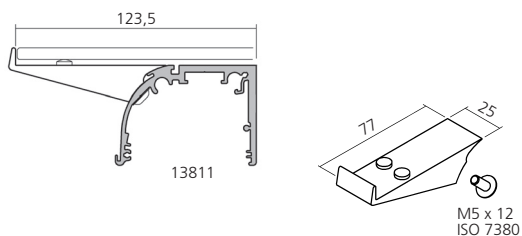
 a 60°
 L 300 / L1 193 **24013**
 L 350 / L1 243 **24014**

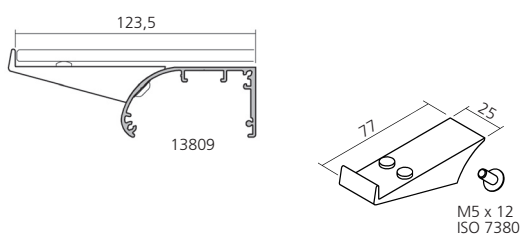
 a 70°
 L 300 / L1 193 **24011**
 L 350 / L1 243 **24012**

 nach Angabe
 on indication **24015**

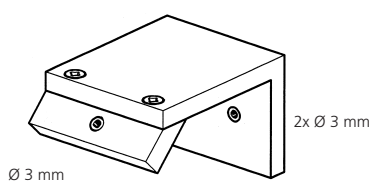
 Vorsatzträger, Aluminium
 Preset bracket

23876

 Vorsatzträger, Aluminium
 Preset bracket

23897

 Bohrschablone, Aluminium
 Drilling jig

23878

 passend für Beleuchtungsblende 13811 / 13809
 compatible for light shield 13811 / 13809

Zwischenträger
 Intermediate bracket

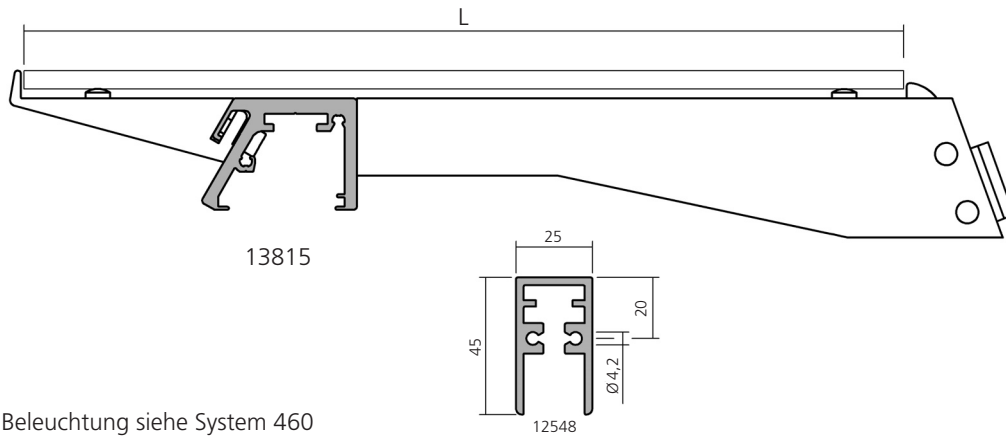
270

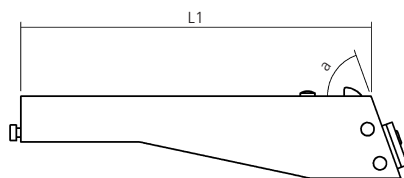

 Zubehör für Beleuchtung siehe System 460
 Accessories for lighting find at system 460

 Darstellung
 Image **40%**

 Zwischenträger, Aluminium
 Intermediate bracket

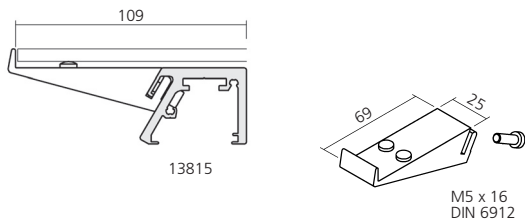
 a 60°
 L 300 / L1 208 **24023**
 L 350 / L1 258 **24024**

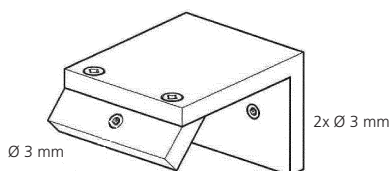
 a 70°
 L 300 / L1 208 **24021**
 L 350 / L1 258 **24022**

 nach Angabe **24025**
 on indication

 Vorsatzträger, Aluminium
 Preset bracket

23951

 Bohrschablone, Aluminium
 Drilling jig

23493

 passend für Beleuchtungsblende 13815
 compatible for light shield 13815

Zwischenträger
 Intermediate bracket

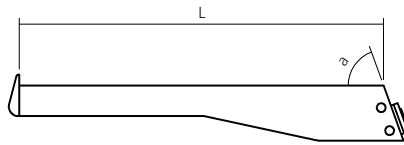
270

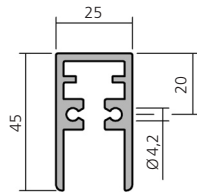

 Zwischenträger, Aluminium
 komplett montiert
 Intermediate bracket
 completely assembled

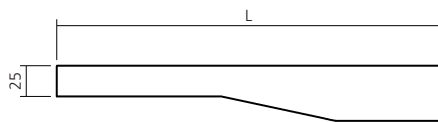
 a 60 °
 L 300 mm **21348**
 L 350 mm **21381**
 L 400 mm **21384**
 L 450 mm **21387**

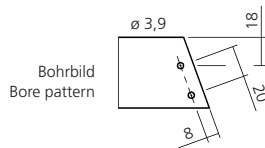
 a 70°
 L 300 mm **21347**
 L 350 mm **21380**
 L 400 mm **21383**
 L 450 mm **21386**

 a nach Angabe
 a on indication
 L 300 mm **21349**
 L 350 mm **21382**
 L 400 mm **21385**
 L 450 mm **21388**

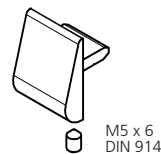
 Zwischenträger, Aluminium
 ohne Neigung
 Intermediate bracket
 without degree

 L 300 mm **21350**
 L 400 mm **21351**
 L 500 mm **21352**

 ohne Zubehör
 without accessories

 Trägernase, Aluminium
 Support catch

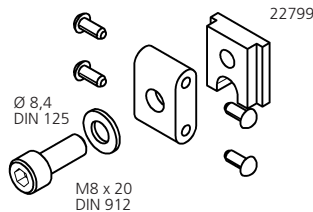
22982

 M5 x 6
 DIN 914

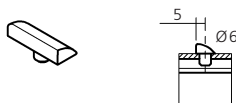
 Befestigung, Aluminium
 Clamping piece

22798

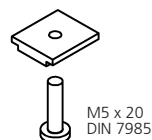
 Glasanschlag, Kunststoff
 Glass stop, plastic

21354

 Klemmstück
 Clamping piece

21355

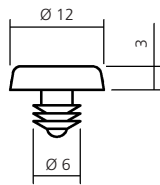
 M5 x 20
 DIN 7985

Zwischenträger
Intermediate bracket

270



Glasbodenauflage, Kunststoff
Support for Glass, plastic

22578

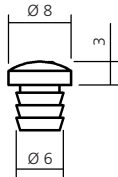

Glasbodenauflage, Kunststoff
Support for Glass, plastic

51249

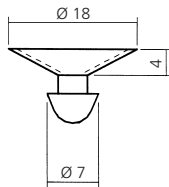

Glasbodenauflage, Kunststoff
Support for Glass, plastic

71725