

Darstellung
Image **50%**

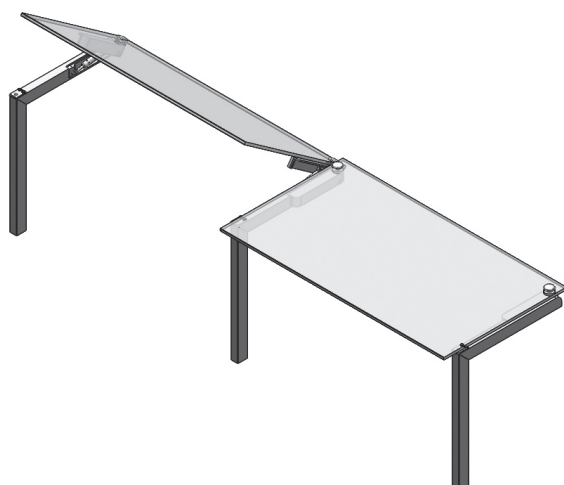

Hebebeschlag für Deckglas
max. Deckglasgröße L = 850–1300 mm
max. Deckglastiefe T = 300–500 mm
Öffnungswinkel 80°

Lifting armature for upper glass
max. upper glass size L = 850–1300 mm
max. upper glass size T = 300–500 mm
opening angle 80°

Wir empfehlen ESG-Glas in allen
Thekenaufbauten zu verwenden.

We recommend always toughened
safety glass for all our systems.

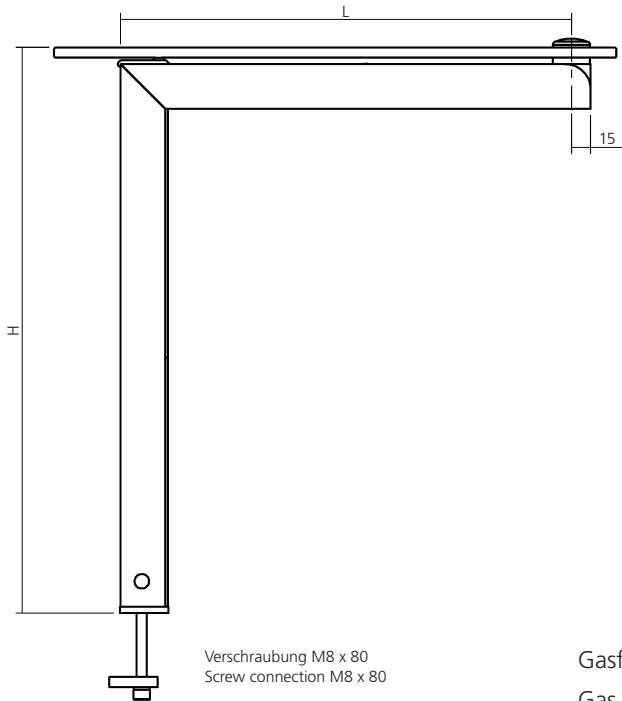

Gasfeder ist nicht im Lieferumfang enthalten.
Gas ram not included in delivery.

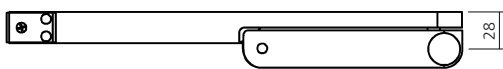

Stütze links
mit Verschraubung
Support left
with screw connection

Abmessungen **26301**
nach Angabe
Dimensions
according
to indication

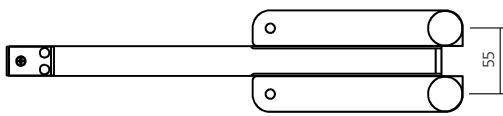

Stütze Mitte
mit Verschraubung
Support center
with screw connection

Abmessungen **26303**
nach Angabe
Dimensions
according
to indication

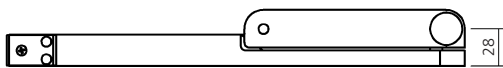

Stütze rechts
mit Verschraubung
Support right
with screw connection

Abmessungen **26302**
nach Angabe
Dimensions
according
to indication

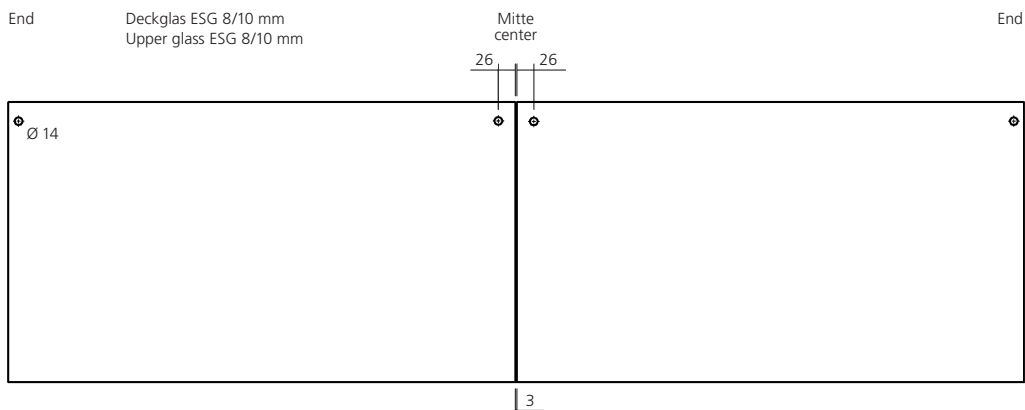

Hebebeschlag
 Lifting armature

345

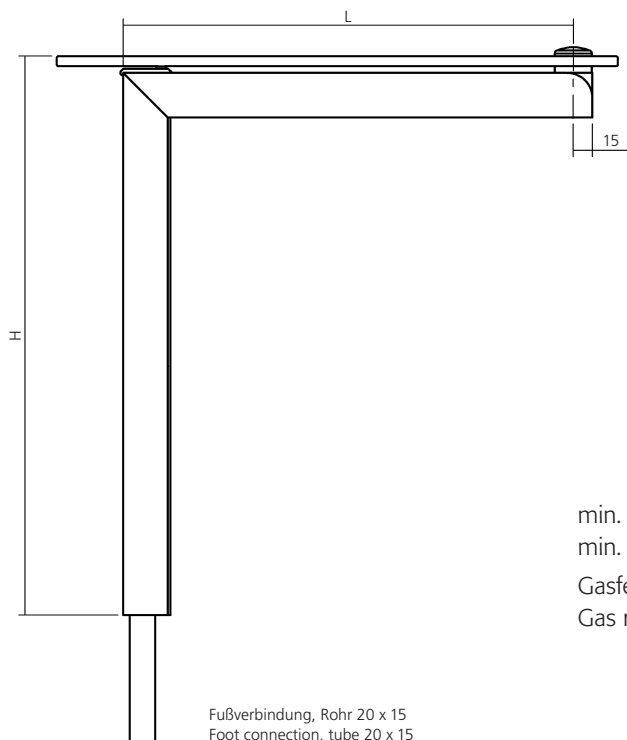

min. Trägerlänge $L = 230$ mm
 min. bracket length $L = 230$ mm
 Gasfeder ist nicht im Lieferumfang enthalten.
 Gas ram not included in delivery.

Fußverbindung, Rohr 20 x 15
 Foot connection, tube 20 x 15

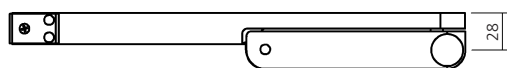

Stütze links
 mit Fußverbindung
 Support left
 with foot connection

Abmessungen **26351**
 nach Angabe
 Dimensions
 according
 to indication

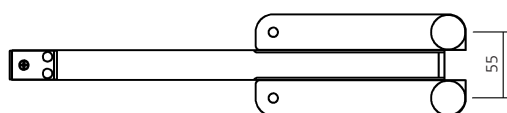

Stütze Mitte
 mit Fußverbindung
 Support center
 with foot connection

Abmessungen **26353**
 nach Angabe
 Dimensions
 according
 to indication

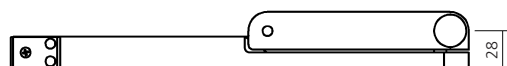

Stütze rechts
 mit Fußverbindung
 Support right
 with foot connection

Abmessungen **26352**
 nach Angabe
 Dimensions
 according
 to indication

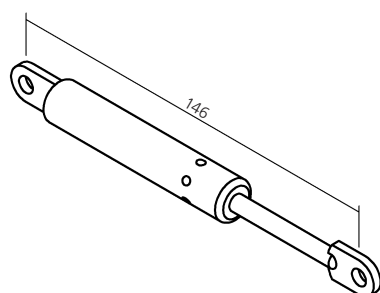

Gasfeder	200 N	26386
Gas ram	300 N	26387
	400 N	26388
	500 N	26389

Hebebeschlag
Lifting armature

345

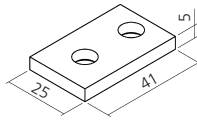

Rosette, Aluminium
für Verschraubung
Collar
for screw connection

25016

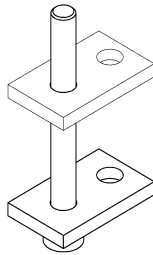

Verschraubung
Screw connection

25018

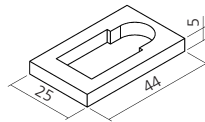

Rosette, Aluminium
für Fußverbindung
Collar
for foot connection

25038

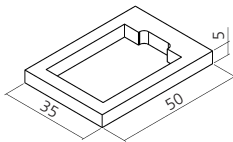

Überwurfrosette, Aluminium
Retaining – collar

25039

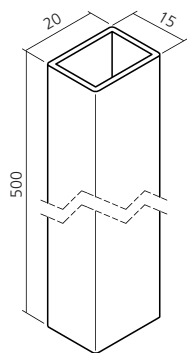

Rohr, Edelstahl
für Fußverbindung
Tube, stainless steel
for foot connection

26020