

Öffnungswinkel
Opening angle

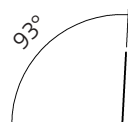

Zubehör für Beleuchtung siehe System 460, 470
Accessories for lighting find at system 460, 470

Griff- und Anschlagprofil siehe System 380-382
Grip- and stopprofile find at system 380-382

Darstellung
Image **50%**

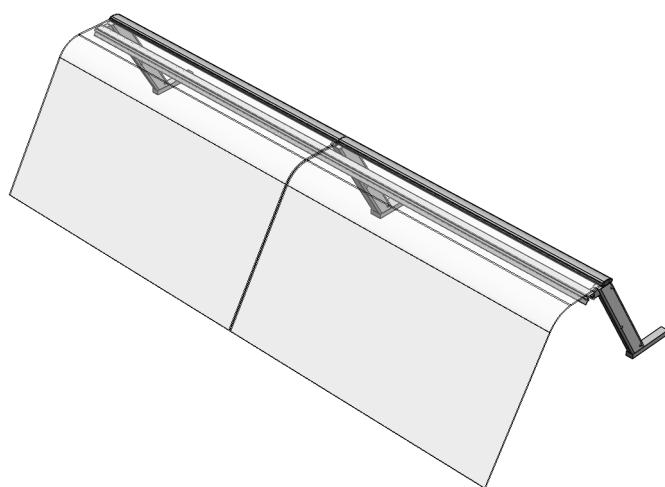

Hebebeschlag für Panoramasscheiben
max. Glaslänge 1443 mm
Lifting armature for panorama glasses
max. glass length 1443 mm

Wir empfehlen ESG-Glas in allen
Thekenaufbauten zu verwenden.
We recommend always toughened
safety glass for all our systems.

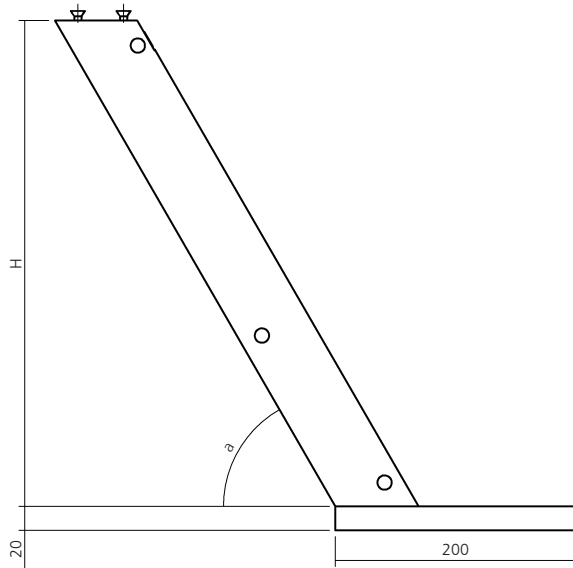

Gasfeder ist nicht im Lieferumfang enthalten.
 Gas ram not included in delivery.

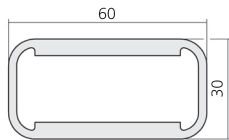

Endstütze
 aus Profil 11951
 End support completely assembled
 out of profile 11951

Abmessungen nach Angabe **22641**
 Dimensions according to indication

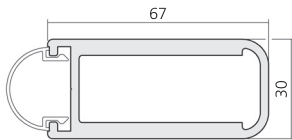

Endstütze
 aus Profil 11962/12027
 End support completely assembled
 out of profile 11962/12027

Abmessungen nach Angabe **22643**
 Dimensions according to indication

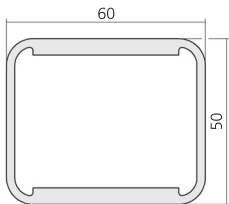

Mittelstütze
 aus Profil 11952
 Central support
 out of profile 11952

Abmessungen nach Angabe **22642**
 Dimensions according to indication

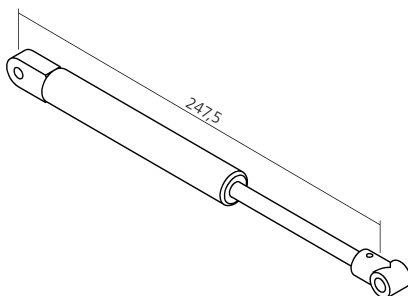

Gasfeder – Liftomat	300 N	22633
Gas ram – Liftomat	400 N	22635
	500 N	22684
	600 N	22648
Scheibenlänge	Federkraft	700 N
Length of pane	Pressure force	800 N
943 mm	2 x 400 N	22685
1243 mm	2 x 500 N	22686
1443 mm	2 x 600 N	

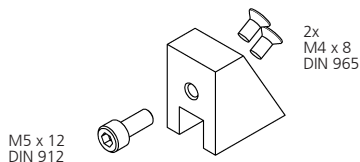

Blendenhalter, Aluminium
 Shield holder

Neigung nach Angabe **22657**
 Degree to indication

Hebebeschlag
 Lifting armature

351

	Glashalteprofil, Aluminium Glass clamp Profil	6000 mm	12415
	Glashalteprofil, Aluminium Glass clamp Profil	6000 mm	12407
		Bohrabstand Bore distance 150 mm	
	Schraube M6 x 8 DIN 913 Screw M6 x 8 DIN 913	VPE 25	SC006
		PU 25	
	Einfassprofil, PVC Bordering profile, PVC	3000 mm	22710
<p>Abstand Endstütze Distance end support</p> <p>Abstand Mittelstütze Distance central support</p> <p>Ø 6,6</p>	Bohrschablone für Glashalteprofil 12407 Drill jig for glass holding profile 12407		23485
<p>Endstütze End support</p> <p>Mittelstütze Central support</p> <p>90°</p> <p>Ø 12,4</p> <p>0,6</p> <p>Ø 6,6</p> <p>28</p> <p>10,5</p>			
<p>rechts/right</p> <p>2x M3 x 10 DIN 7500-M</p>	Endkappe, Aluminium End cap	rechts / right links / left	24060 24061
<p>Ø2,7 x 12</p> <p>28</p> <p>10,5</p> <p>4,5</p>	Bohrschablone für Endkappe rechts / links Drill jig for end cap right / left		23486
<p>2 x M5 x 12 DIN 7380</p> <p>2 x M6 x 16 DIN 7991</p>	Schwenklager für Eckgläser Pivoting block for corner glasses		22669