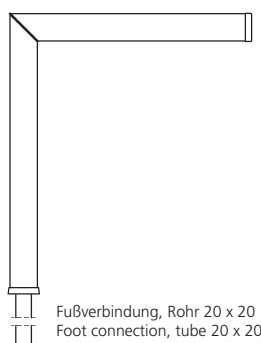
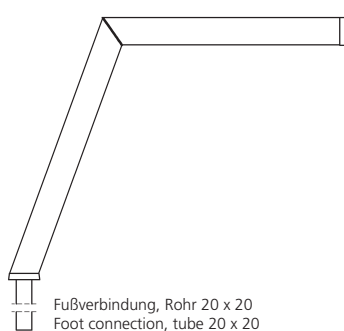
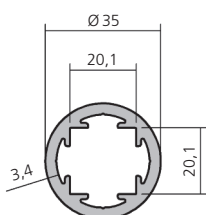
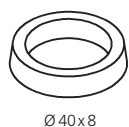

 Darstellung
 Image **20%**

 Stütze 90°
 Support

 Abmessungen
 nach Angabe
 Dimensions
 according
 to indication
22597
 Stütze 70°
 Support

 Abmessungen
 nach Angabe
 Dimensions
 according
 to indication
22598
 Stützenprofil, Aluminium
 Support profile

6000 mm

17062
 Rosette, Aluminium
 Collar
22503

Glasstützenprogramm
 Glass support program

423

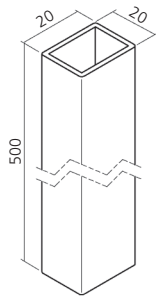
 Rohr, Edelstahl
 für Fußverbindung
 Tube, stainless steel
 for foot connection

90°

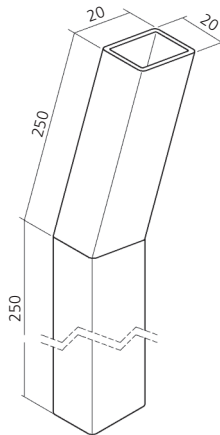
22537
 Rohr, Edelstahl
 für Fußverbindung
 Tube, stainless steel
 for foot connection

70°

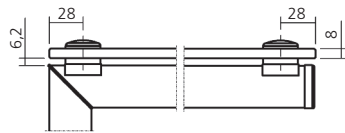
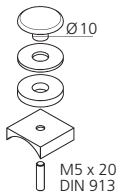
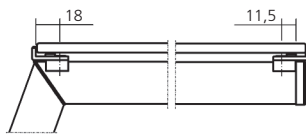
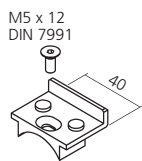
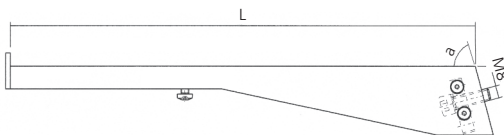
22530
 Glasbefestigung, Aluminium
 Glass pane fixture
22524
 Glasauflage, Aluminium
 Glass support
22509
 Zwischenträger, Aluminium
 Intermediate bracket

a 90°

L 250 mm

23145

L 300 mm

23146

L 350 mm

23147

L 400 mm

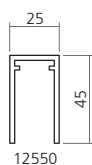
23148

12550

a 70°

L 250 mm

23153

L 300 mm

23154

L 350 mm

23155

L 400 mm

23156

L nach Angabe

L to indication

90°

23151

70°

23152