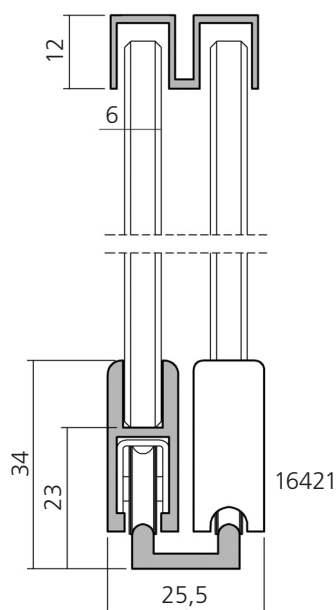
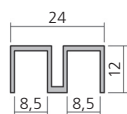
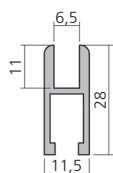
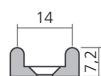

Schiebetürbeschlag für 6 mm Glas
 Sliding door fitting for 6 mm glass

431

 Darstellung
 Image **80%**

 Führungsschiene, Aluminium
 für 6 mm Glas
 Guide rail
 for 6 mm glass

 6000 mm
 ungebohrt/undrilled **16419.0001**
 gebohrt/drilled **16419**

 Laufschuhprofil, Aluminium
 für 6 mm Glas
 Roller shoe profile
 for 6 mm glass

 6000 mm **16420**

 Laufschiene, Aluminium
 Sliding rail

 6000 mm
 ungebohrt/undrilled **16421.0001**
 gebohrt/drilled **16421**

 Lochabstand 300 mm, Ø 4 mm
 Distance of holes 300 mm, Ø 4 mm

 Endkappe, Kunststoff
 End cap, plastic

 Glas / Glass
 6 mm

36422

 Endkappe, Kunststoff
 End cap, plastic

 Glas / Glass
 6 mm

36427

Schiebetürbeschlag horizontal
 Sliding door fitting horizontal

431

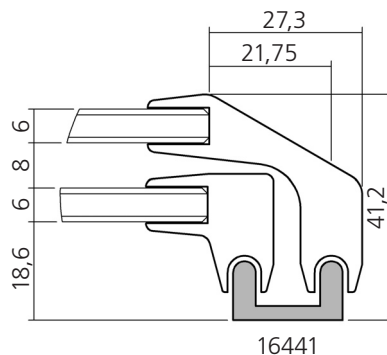

 Darstellung
 Image **70%**

 Laufsuhprofil innen,
 Aluminium
 Roller shoe profile inside

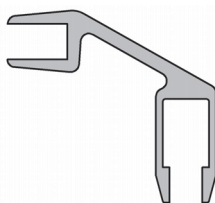
6000 mm

16432
 Laufsuhprofil außen,
 Aluminium
 Roller shoe profile outside

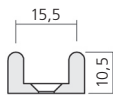
6000 mm

16433
 Lochabstand 300 mm, Ø 4 mm
 Distance of holes 300 mm, Ø 4 mm

 Laufschiene, Aluminium
 Sliding rail

 6000 mm
 ungebohrt/undrilled **16441.0001**
 gebohrt/drilled **16441**

links/left

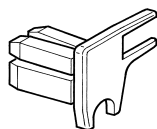
 Endkappe innen, Kunststoff
 End cap inside, plastic

 links / left
 rechts / right
36459**36460**

links/left

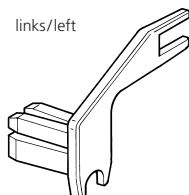
 Endkappe außen, Kunststoff
 End cap outside, plastic

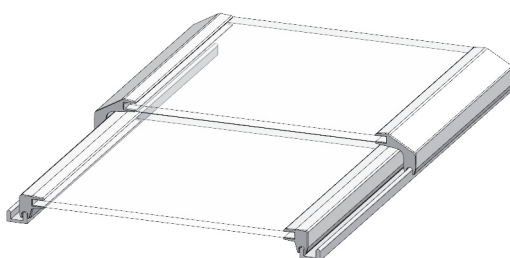
 links / left
 rechts / right
36461**36462**
 Schiebetürbeschlag für horizontales Glas
 max. Glasgröße L = 800 mm T = 500 mm
 Sliding door fitting for horizontal glass
 max. glass size L = 800 mm T = 500 mm

 Wir empfehlen ESG-Glas in allen
 Thekenaufbauten zu verwenden.

 We recommend always toughened
 safety glass for all our systems.

Zubehör für Schiebetürbeschlag
Accessory for sliding door fitting

431

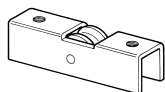

Rolleneinsatz für 6 mm Glas
Edelstahlgehäuse / Kunststoffrolle
Roller insert for 6 mm glass
Stainless steel / plastic role

36429

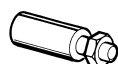

Anschlag mit Gummiüberzug
End stop with rubber cover

36441

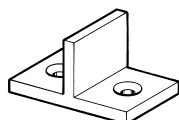

T-Stück für 36441, Aluminium
T-piece for 36441

36442

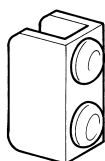

U-Profil mit Anschlag
U-profile with end stop

6 mm

36443

8 mm

36444

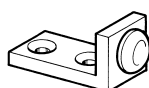

Winkel mit Anschlag, Aluminium
Angle with end stop

36446

rechts/right

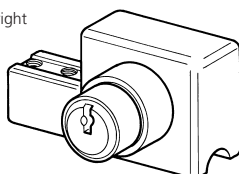

Druckschloss für 16420, verchromt
mit Gehäuse
Push button lock for 16420
Chrome plated, with housing

links / left

36455

rechts / right

36456

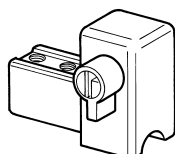

Steckschloss für 16420, vernickelt
mit Gehäuse
Push button lock for 16420
Nickeled, with housing

36457

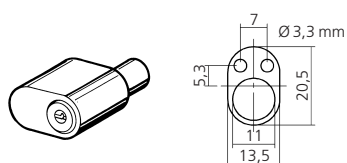

Einbauzylinder für 16440
Installation cylinder for 16440

36436

Schiebetürbeschlag für 6 mm Glas
 Sliding door fitting for 6 mm glass

431

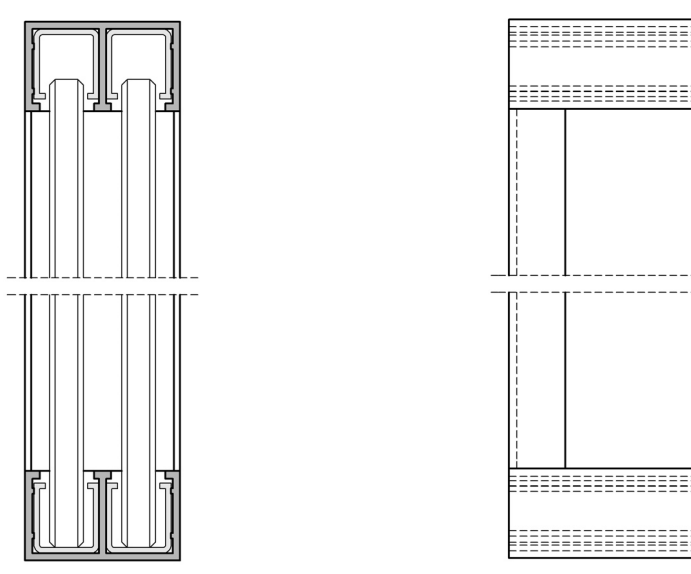
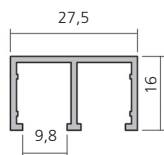
 Darstellung
 Image **70%**

 Führungsschiene, Aluminium
 unten / oben
 Guide rail
 down / above

6000 mm

16460
 Gleitprofil, Kunststoff schwarz
 Slide profile, plastic black

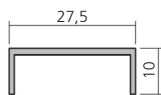
6000 mm

16461
 Führungsschiene, Aluminium
 seitlich
 Guide rail
 laterally

6000 mm

16462